

SK系列精密不锈钢手动直线滑台

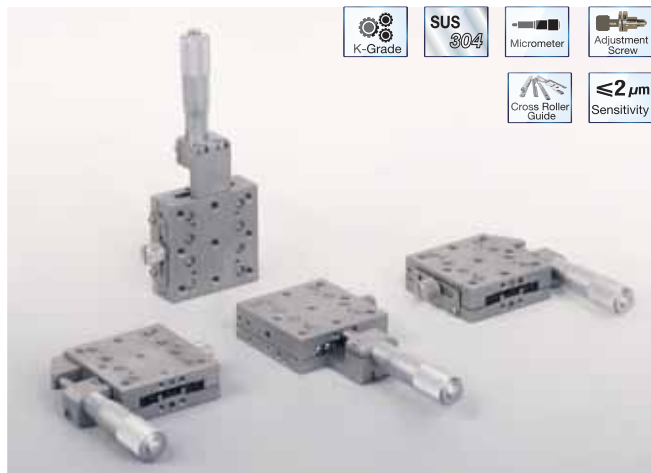
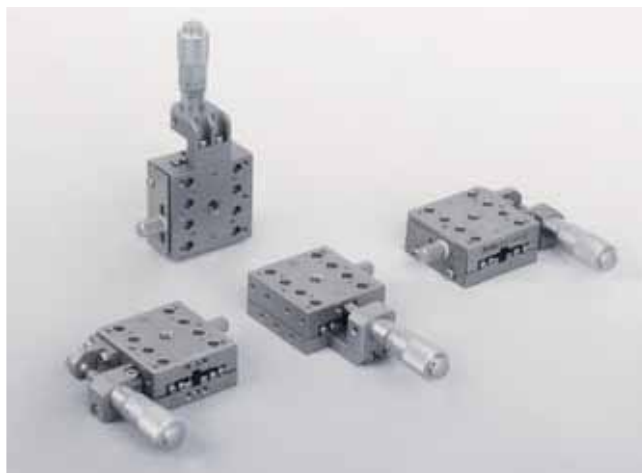

说明:

SK 系列产品是卓立汉光开发的高精密手动直线滑台。该产品主体材料采用 304 不锈钢，采用超高精密交叉滚柱导轨导向，精密分厘卡（或微调螺纹副）驱动，配合卓立汉光的精密加工技术，使该系列产品具有不小于 $2\mu\text{m}$ 的高灵敏度，并且运行平顺，无跳动现象。该系列产品具有很高的通用性，适合于高精度的手动调整领域，尤其适合对负载能力、运动精度有较高要求的场合，也可在真空中使用（需换装真空脂）。

特点:

- 灵敏度 $\leq 2\mu\text{m}$
- 主体材料为 304 不锈钢，稳定性高、耐腐蚀性好，也适合在真空中使用
- 高精密交叉滚柱导轨，保证了产品的灵敏度、直线度等关键指标达到国内领先水平
- 具有分厘卡和微调螺纹副 2 种驱动方式，分为左侧、右侧、中间驱动，使用灵活方便，可选配差分厘卡
- 负载能力较强，尺寸适中，适合绝大多数应用环境

命名规则

SK 13 (A)-40 SR



选型表

型号	SK13(A)-40(xx)	SK13(A)-60(xx)	SK25(A)-65(xx)
行程(mm)	13	13	25
台面尺寸(mm)	40×40	60×60	65×65
厚度(mm)	19.5	20	23
导轨	交叉滚柱导轨		
驱动方式	螺纹副(带A为分厘卡)		
驱动位置	C: 中心驱动; SR: 右侧驱动; SL: 左侧驱动; CZ: 中心竖直驱动		
主体材料及表面处理	不锈钢, 喷砂钝化		
灵敏度(μm)	≤ 2		
分厘卡最小读数(mm)	0.01		
直线度(μm)	≤ 3		
水平负载(Kg)	5	6	7
竖直负载(Kg)	1.5	2	2.5
自重(Kg)	0.28	0.5	0.86

注: 竖直负载仅限“-xZ”型的直线滑台

SK13(A)-40系列精密手动直线滑台

尺寸图:

SK13-40C

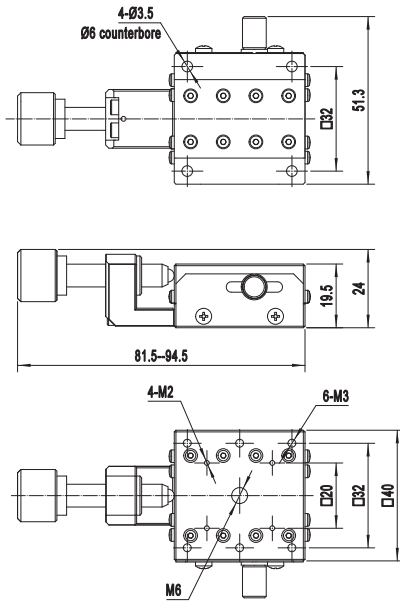
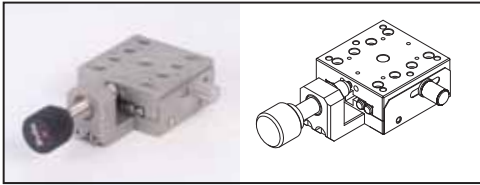

SK13A-40C

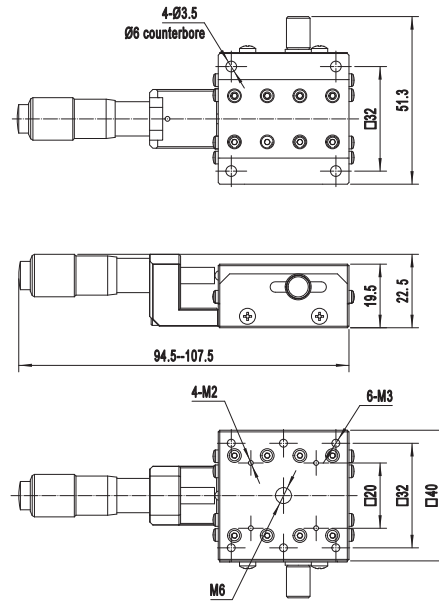
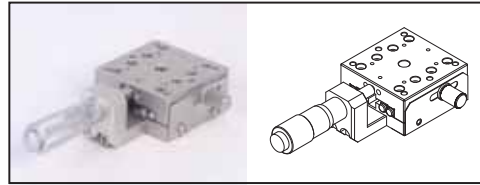

SK13-40CZ

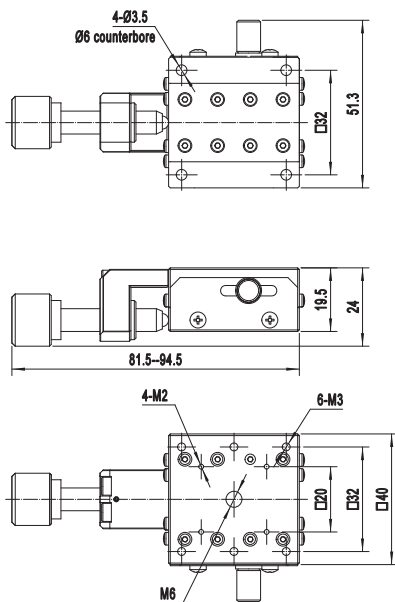
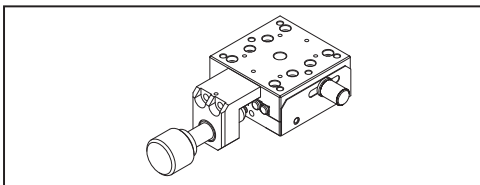

SK13A-40CZ

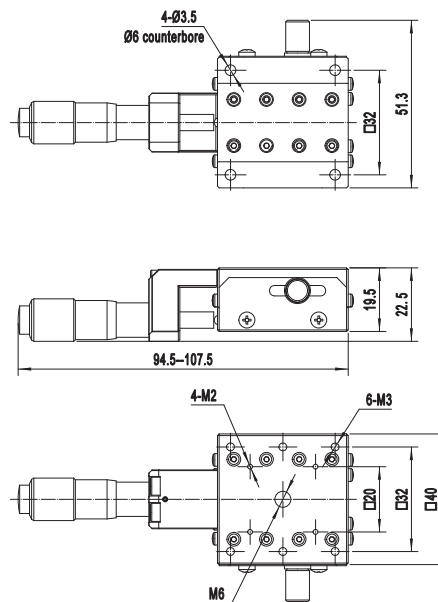
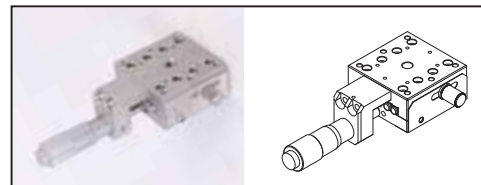

SK13-40SR

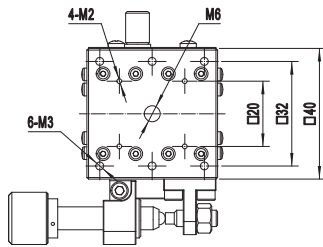
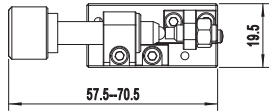
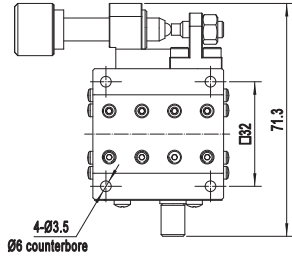
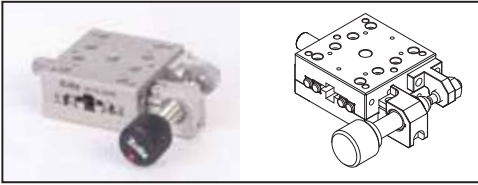

SK13A-40SR

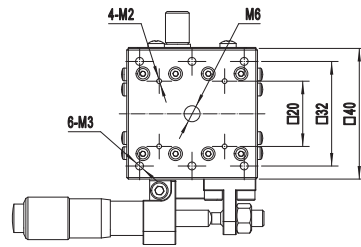
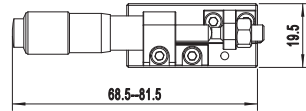
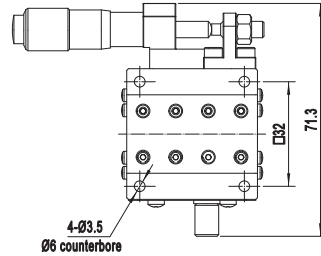
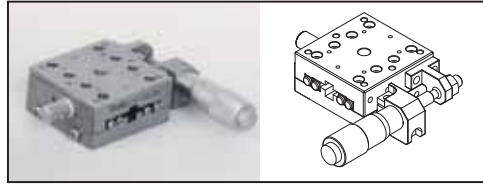

SK13-40SL

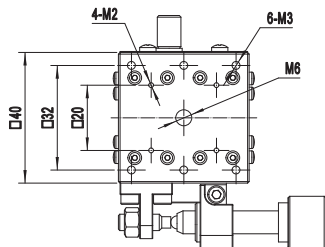
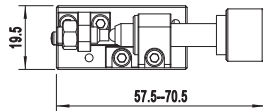
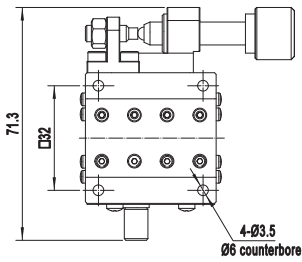
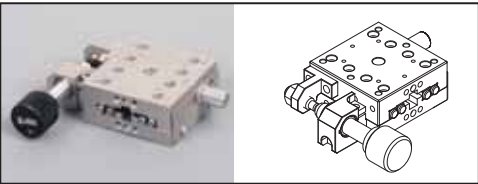

SK13A-40SL

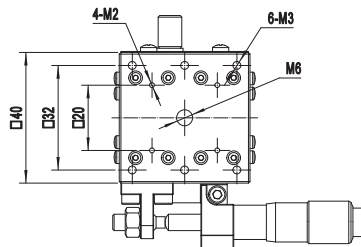
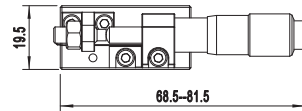
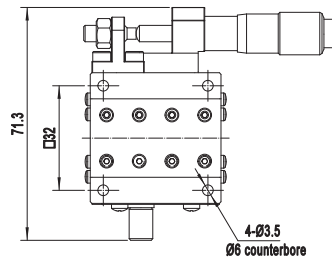
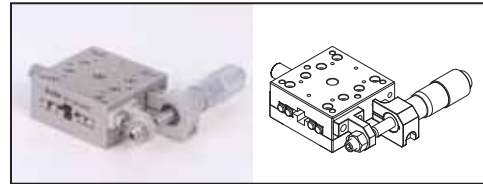

SK13(A)-60系列高精度手动直线滑台

SK13-60C

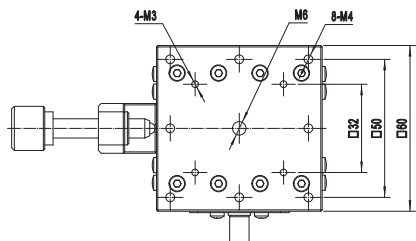
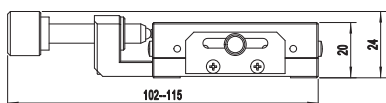
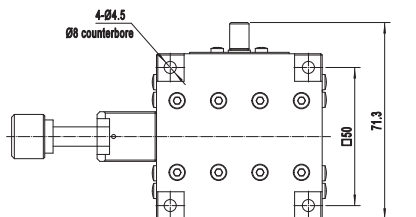
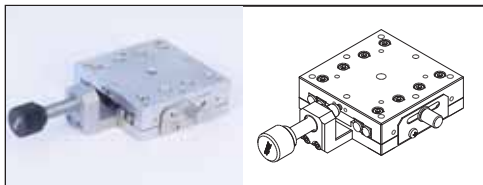

SK13A-60C

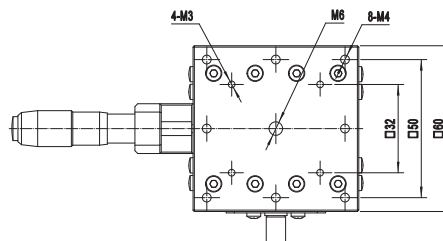
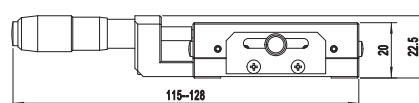
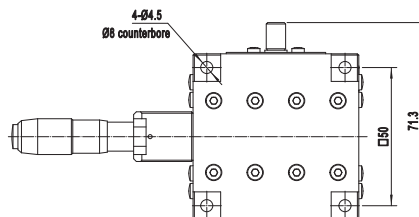
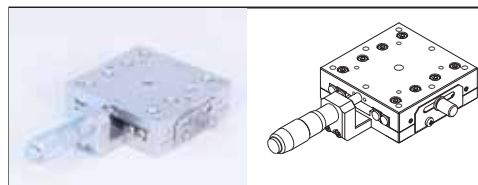

SK13-60CZ

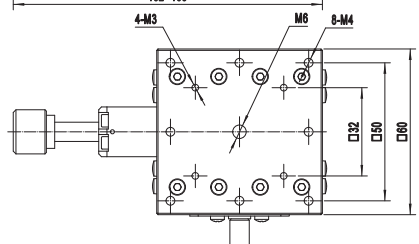
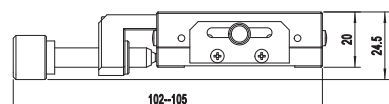
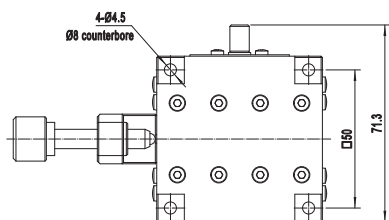
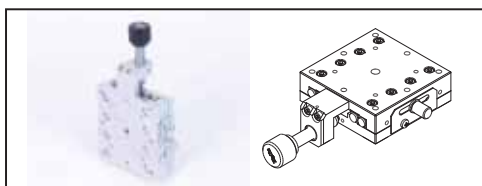

SK13A-60CZ

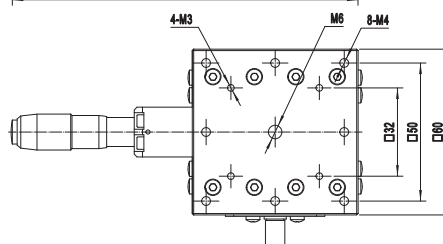
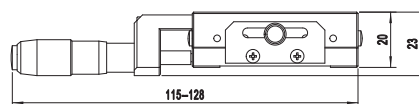
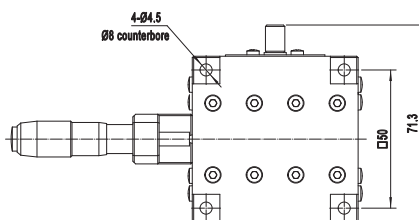
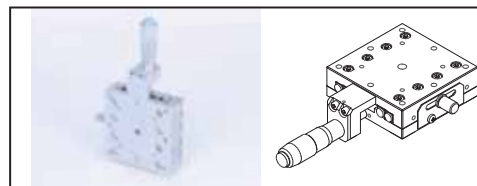

SK13-60SR

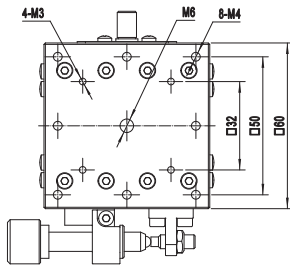
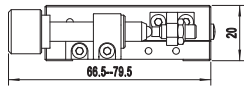
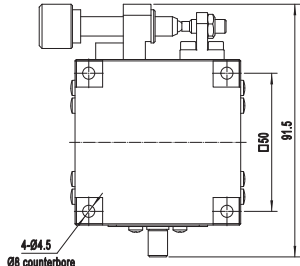
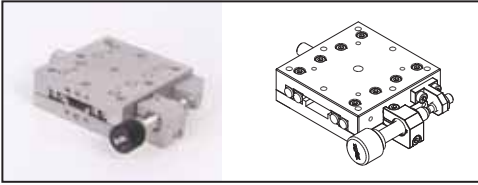

SK13A-60SR

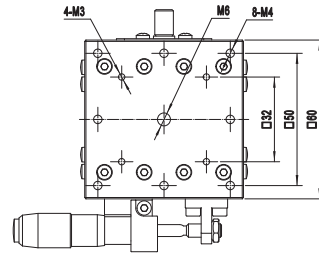
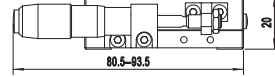
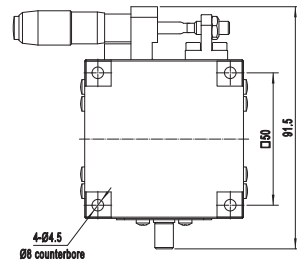
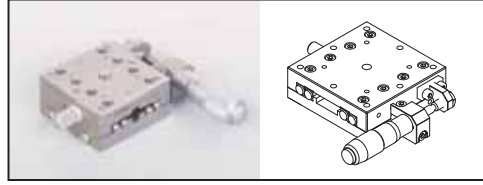

SK13-60SL

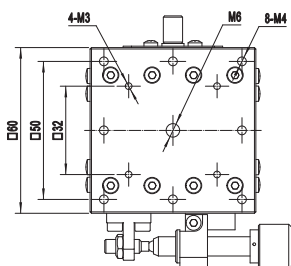
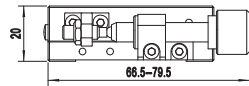
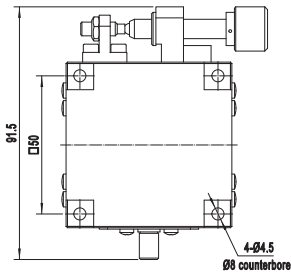
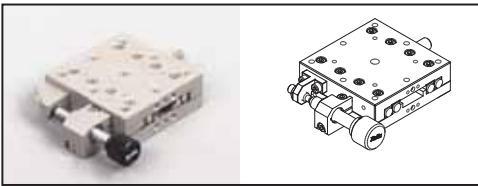

SK13A-60SL

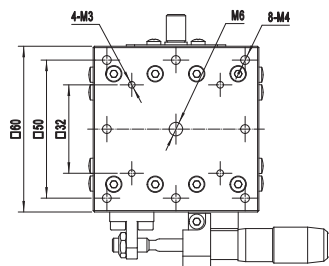
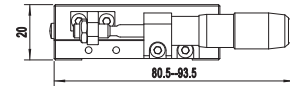
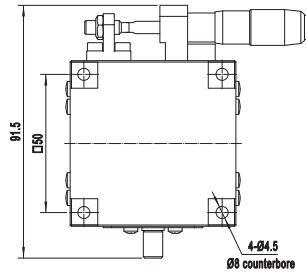
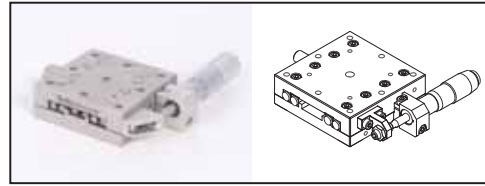

SK25(A)-65系列高精度手动直线滑台

SK25-65C

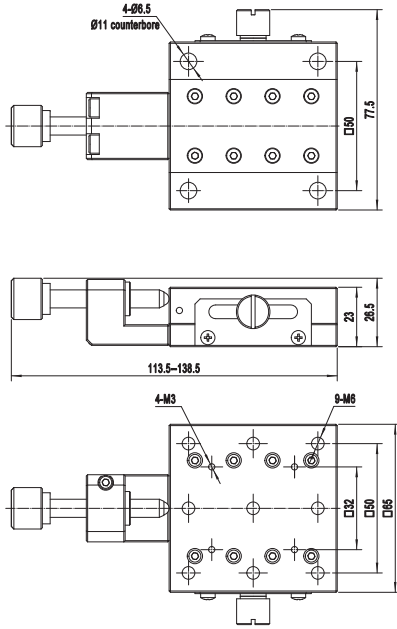
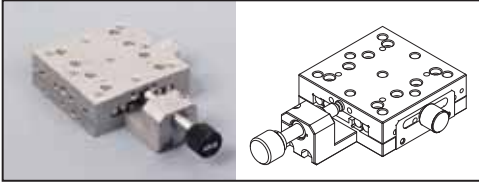

SK25A-65C

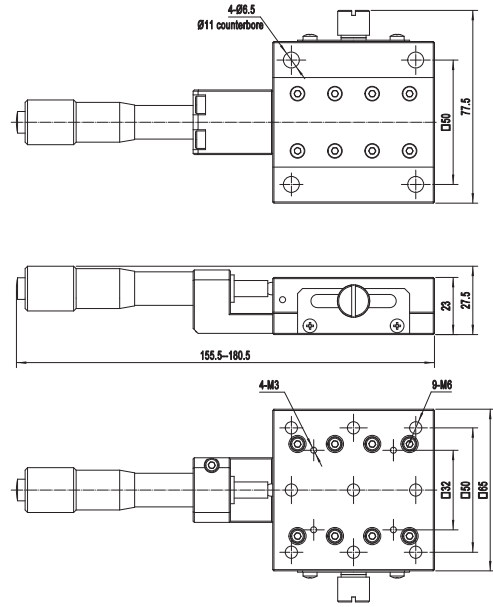
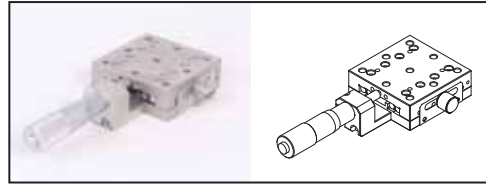

SK25-65CZ

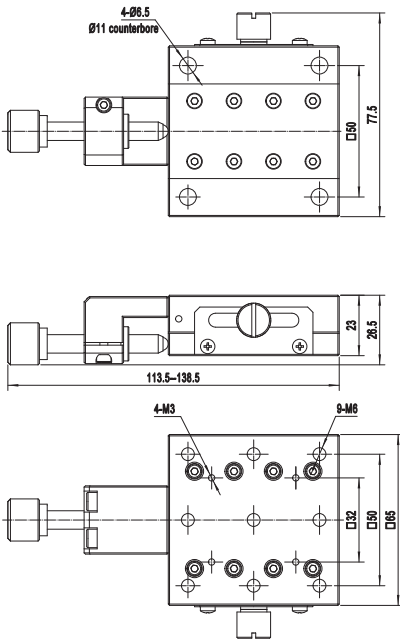
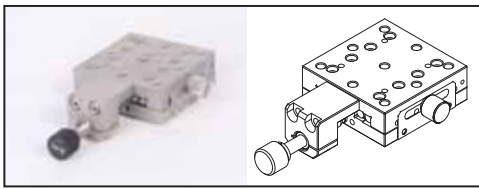

SK25A-65CZ

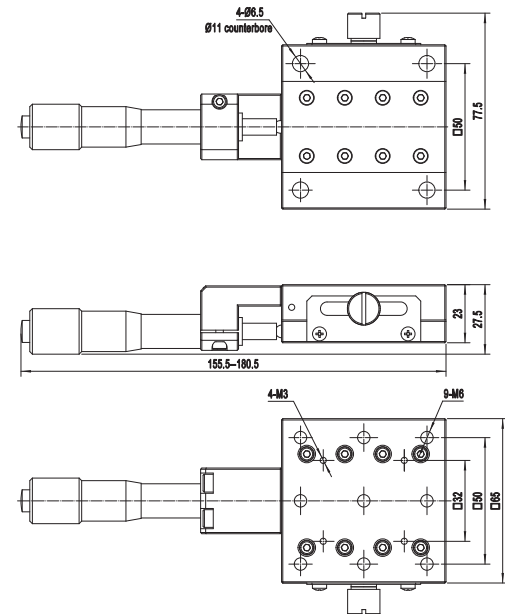
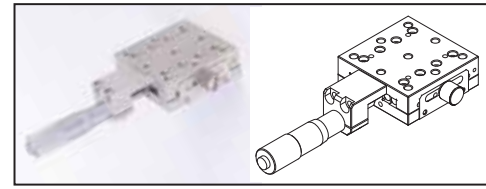

SK25-65SR

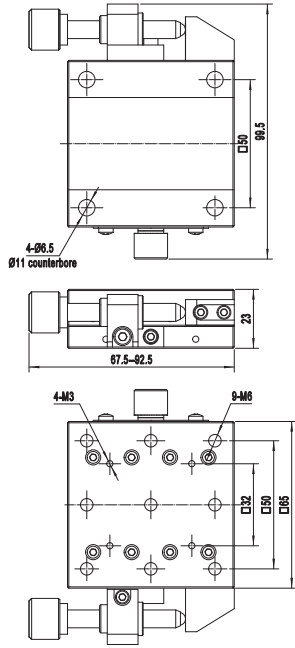
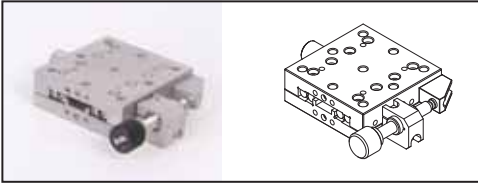

SK25A-65SR

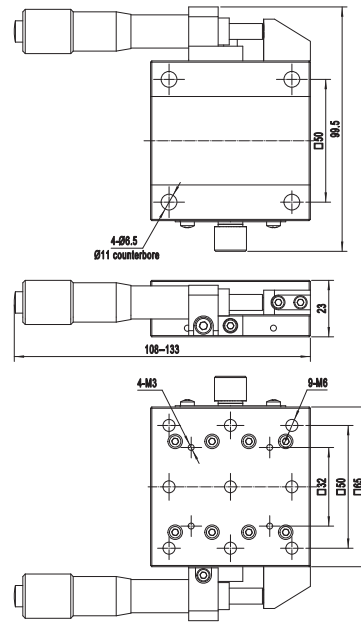
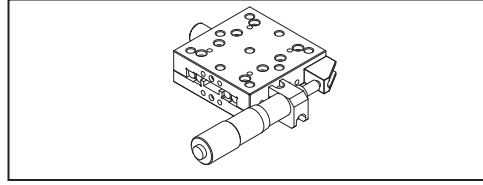

SK25-65SL

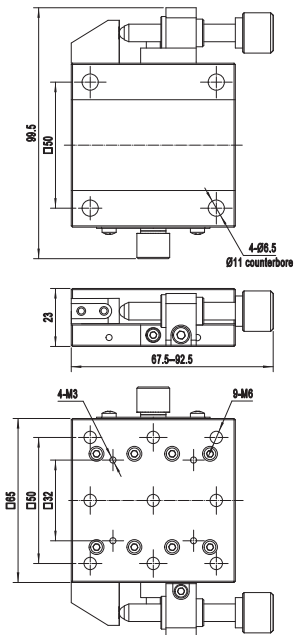
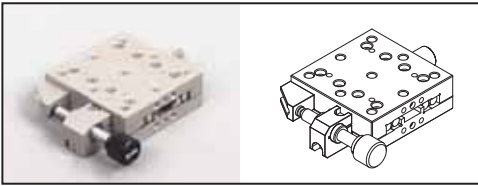

SK25A-65SL

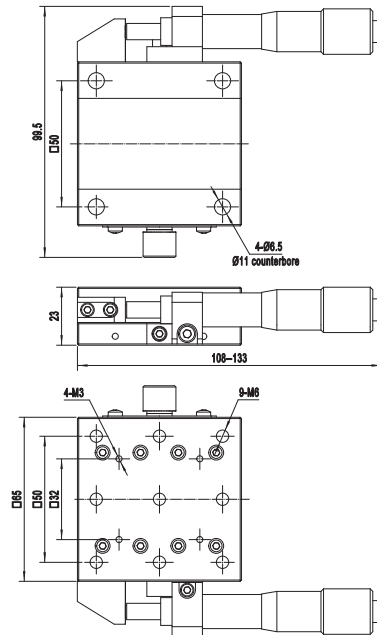
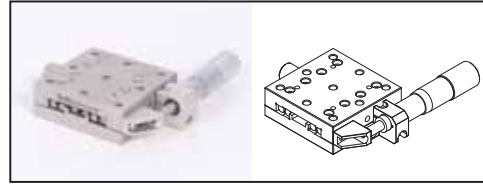

转接附件详见314~320页。